



professional poolware

BLUE Professional Poolware
Positioning control for pool cover

1 Manufacturer's Address

<p>BLUE Professional Poolware bv Korenmijt 1, 5741 PP Beek en Donk Tel. +31 (0)85 076 88 85 Mail : info@blueppw.com</p>	
--	--

Table of contents

1	Manufacturer's Address.....	0
2	General information.....	2
2.1	Important information	2
2.2	Technical data	2
2.3	Symbols legend and description	3
2.5	Hazard information	3
2.6	Validity	3
2.7	Intended use	4
2.8	General safety and usage information	4
2.9	Disposal.....	5
2.10	Delivery contents.....	5
2.11	Additional information.....	5
3	Operation.....	5
3.1	Optional stop switch	5
3.2	Key switch operation	5
3.2.1	Key switch with automatic reset.....	5
<i>Hold mode</i>	6	
3.3	Pushbutton operation	6
3.4	Optional remote control operation.....	7
5	Assembly of BLUE.....	9
6	Electrical connection.....	10
6.1	Wiring diagram.....	10
6.2	Cable inlets	10
6.3	Power connection	10
6.4	Terminals	10
6.5	BLUE motor connection	11
6.5.1	7-wire connection cable, standard design.....	11
6.5.2	7-wire standard cable, 5-wire motor connecting	12
6.6	Key switch connection	13
6.7	Pushbutton connection touch control.....	13
6.8	Water level monitoring connection.....	13
7	Start-up.....	13
7.1	Select language	14
7.2	Programming the final positions	14
7.2.1	Activation	14
7.2.2	Testing the motor's rotation direction	15
7.2.3	Programming the OPEN position	15
7.2.4	Programming the CLOSED position	15
7.3	Information shown on display 16	16
8	Maintenance and upkeep	16
9	Error messages	17
10	PC connection (USB interface)	17
10.1	Relays connection functions	18
10.1.2	"Drive" function.....	18
10.2	Drive mode configuration	18
10.2.1	MODE EU 1, Standard configuration	18
10.2.2	MODE EU 2, France	18
10.2.3	MODE EU 3, Stop operation in both directions.....	18
10.2.4	MODE EU 4, TOUCH CONTROL.....	18
10.2.5	MODE EU 5, external 1-channel remote control.....	18
11	Commissioning certificate	19

2 General information

2.1 Important information

Operation Guarantee	Observance of these operating instructions is essential to ensure trouble-free operation and in order for any warranty entitlements to be honoured. Read the operating manual carefully before working with the BLUE control unit.
Proper use	The BLUE control unit is designed for use in privately-used pools. It may not be used in public swimming pools.
Note	This operating manual contains instructions for the operation, storage, setup and maintenance of the BLUE control unit.
Start-up Maintenance Setup	The personnel entrusted with the handling, storage, installation, start-up, inspection and maintenance of the machine must be qualified for industrial, mechanical and electrical equipment.
Disposal	The current and regional regulations must be observed for disposal. The electronic components and plastic components are to be disposed of in accordance with environmental protection regulations.

2.2 Technical data

Model	BLUE 120	BLUE 150	BLUE 180	BLUE 250	BLUE 300
Supply voltage	230V AC				
Frequency range	50/60Hz				
Rated current	2.5A				
Rated power	160VA	160VA	160VA	200VA	300VA
Power-on time	Maximum of 15 min. (S2 – 15 min)				
Motor voltage	24VDC				
Motor current limit	5.8A	6.8A	7.0A	8.0A	9.0A
Motor fuse	7.5A	7.5A	7.5A	7.5A	7.5A
Ambient temperature	-10°C to +60°C				
Site altitude	up to 1000 m above sea level				
Humidity	Max. 90%, no condensation				
Protection class	IP54, Protection classification I				
Break connection	24V DC, maximum 1.0A				
Voltage impulse transmitter	5V DC – 24V DC				
Switching level	4.5V < High < 24V 0V < Low: <1.0V				
Dimensions	240mm x 465mm x 100mm				
Weight	2.9 kg				

2.3 Symbols legend and description

{ DANGER DUE TO ELECTRICAL CURRENT

Failure to observe this can result in death, serious injury or property damage.

} DANGER

Failure to observe can result in personal injury or material damage.

) NOTE

Note supplementary information.

2.4 Information for the user, target group

This documentation contains the necessary information for proper use of the products described therein. It is intended for technically qualified personnel. Qualified personnel are persons who - because of their education, experience, instructions, and knowledge about corresponding standards and regulations, rules for the prevention of accidents, and operating conditions - are authorised by the person responsible for the safety of the machine to perform the required actions and who are able to recognise and avoid potential hazards (definition of qualified personnel according to IEC 364).

2.5 Hazard information

The following directions are for the safety of the service personnel as well as for the safety of the described products as well as any connected devices.

{ Warning! Dangerous electrical voltage.

Failure to observe this can result in death, serious injury or property damage.

- Isolate supply voltage before installation or removal work as well as in case of fuse replacement or modifications of the setup.
- Observe the accident prevention and safety regulations that apply to the specific area of use.
- Before putting the machine into operation, check whether the rated voltage coincides with the local mains voltage.
- Emergency stop devices must remain operational in all modes of operation. Disabling the emergency stop devices may not cause an uncontrolled restart.
- The electrical connections must be covered!
- Ground wire connections must be checked for fault-free function after installation!
- The conditions described in DIN VDE 0100-702:2003-11 must be observed.

2.6 Validity

This document applies to the BLUE control unit from the BLUE series

} Safety Information

Adherence to this information is the prerequisite for trouble-free operation and the fulfilment of any guarantee claims.

2.7 Intended use

) **Note:** The devices described here are electrical equipment for use in swimming pools and other pools and may only be used under the following conditions:

Exceptions: the manufacturer has designed the product specifically for other applications and ambient conditions.

The BLUE control unit ...

- ...must only be used for the intended purposes and those confirmed in the shipping documents.
- ... must only be operated under the operating conditions stipulated in the operating instructions and within the power limits.
- ... complies with the valid standards and regulations.
- ... is a component designed for use in privately-used swimming pools.
- **Improper use**
- Use in potentially explosive areas
- Use in harsh environments (acids, gases, vapours, dust, oil)
- Use in a sewage area
- Control unit use in 0 zone as per DIN VDE 0100-702:2003-11

2.8 General safety and usage information

At the time of delivery, the BLUE control unit and its components are considered to be state of the art and fundamentally safe to operate.

) **All transport, storage, installation/assembly, connection, commissioning, maintenance and servicing work may only be performed by qualified personnel.**

During such work, qualified personnel must observe:

- the supplementary safety instructions in the individual chapters of this documentation.
- the safety instructions in attached supplementary sheets and further documents from subcontractors.
- this documentation and the circuit diagrams.
- the warning and safety signs on the devices.
- the machine-specific regulations and requirements.
- the national and regional regulations for safety and accident prevention.

) **The BLUE control unit can pose a risk to persons, the machine itself and other property belonging to the operator**

- ... if unqualified personnel work on or with the drive system.
- ... if the drive system is used improperly.
- ... if the drive system is installed and operated incorrectly.
- ... if the following information is disregarded:
 - Only operate the control unit when it is in perfect working order.
 - As a general rule, any retrofitting, changes or reconstruction of the drive system is prohibited. The above work may only be performed after consultation with the manufacturer.
 - During operation and for an extended period afterwards, the components may have live parts, moving parts and potentially hot surfaces.

- Start-up (start of proper operation) may only be carried out once there it has been confirmed that the machine complies with EMC Directive 2004/108/EC and that the machine conforms to Machinery Directive 2006/42/EC.
- EN 60204 must be observed.

Should you have any questions or problems, please contact your BLUE representative.

2.9 Disposal

The control unit must be disposed of in compliance with the currently valid regulations of the respective country. Electronic elements and components must be disposed of through a certified specialised company.

2.10 Delivery contents

- Pre-wired control unit with mains supply line, shock-proof plug and options as per specification.
- Additional accessories in accordance with the accompanying papers.

After receiving the delivery, check the delivery contents against the accompanying papers to make sure they are complete. The manufacturer does not offer warranty for claims regarding missing parts submitted at a later date. Any transport damage that is discovered must be reported to the shipping agent without delay.

2.11 Additional information

) NOTE

The customer is responsible for professional installation and setup of the machine. Safety devices and other safety-relevant components are to be installed at the machine site.

3 Operation

}

The operator must have an unobstructed view of the pool. There may not be any people in the pool when opening and/or closing the pool cover. Objects and hoses in the pool can become caught in the cover and potentially destroy the drive motor. If the water level is too low, the cover or motor may also be damaged.

Operation is carried out by a switch installed near the pool. The switch may be either a pushbutton or a key switch. An optional remote control is available for purchase.

3.1 Optional stop switch

If an optional stop switch exists, the motor can be stopped at any time by actuating the switch.

3.2 Key switch operation

3.2.1 Key switch with automatic reset

Touch control

By briefly (less than 1 s) turning the key switch in the desired direction for "opening" or "closing", the pool cover moves to the selected final position and the control unit switches the motor off. This movement can be stopped at any time by turning the key switch (less than 1 s) in the opposite direction or by actuating the optional stop button. By turning the key switch once again in a particular direction, the motor restarts and the moves in the selected final position.

Hold mode

If the key switch is held in the desired direction for a longer period (longer than 1 s), the drive returns to the final position and stops. If the operator releases the switch during the movement, the drive stops immediately and must be restarted.

3.2.2 Key switch with manual reset

By briefly turning the key switch in the desired direction for "opening" or "closing", the pool cover moves to the selected final position and the control unit switches the motor off. The movement can be stopped at any time by turning the key switch to the neutral position. By turning the key switch once again in a particular direction, the motor restarts and moves to the selected final position. After arriving at the final position, turn the key switch back to the neutral position.

3.3 Pushbutton operation

3.3.1.1 Touch control

By briefly (less than 1 s) pressing the pushbutton in the desired direction for "opening" or "closing", the pool cover moves to the selected final position and the control unit switches the motor off. This movement can be stopped at any time by pressing the pushbutton (less than 1 s) in the opposite direction or by actuating the optional stop button. By pressing the pushbutton once again in a particular direction, the motor restarts and moves to the selected final position.

3.3.1.2 Hold Mode

If the pushbutton is held in the desired direction for a longer period (longer than 1 s), the drive returns to the final position and stops. If the operator releases the switch during the movement, the drive stops immediately and must be restarted.

3.4 *Optional remote control operation*

)	The device can be retrofitted with a remote control unit. Please notify the BLUE if desired.
---	--

The pool cover is activated by the two top buttons on the hand-held remote control unit.

Upper button:	press once	to open
	press once	to stop
	press once	to open
Second button:	press once	to close
	press once	to stop
	press once	to close

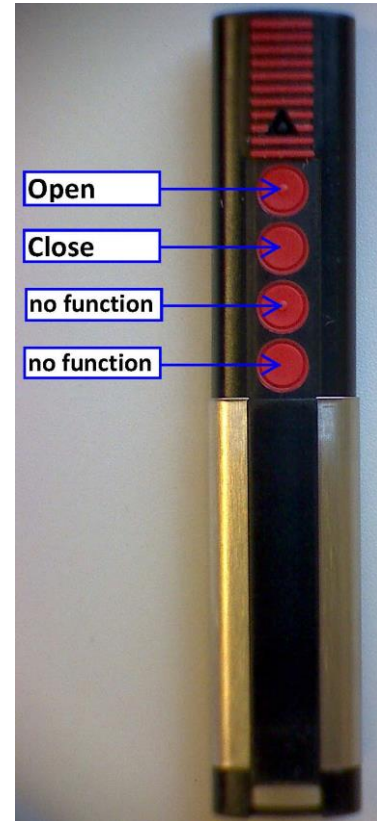

3.5 *Operation with buttons 6 and 7*

3.5.1 *Touch control*

By briefly (less than 1 s) pressing the pushbutton in the desired direction for "opening" or "closing", the pool cover moves to the selected final position and the control unit switches the motor off. This movement can be stopped at any time by pressing the pushbutton in the opposite direction or by actuating the optional stop button. By pressing the pushbutton once again in a particular direction, the motor restarts and moves to the selected final position.

3.5.2 *Hold mode*

If the pushbutton is pressed down in the desired direction for a longer period (longer than 1 s), the drive returns to the final position and stops. If the operator releases the pushbutton during the movement, the drive stops immediately and must be restarted.

4 *Installation site, dimensions*

- Observance of DIN VDE 0100-702 (Installation of low voltage units, section 702: Swimming pools and other pools) is mandatory.
- Installation in area 2 in accordance with DIN VDE 0100-702 is only allowed if the required power outlet is protected by a residual current device (RCD) with a rated differential current of $\leq 30\text{mA}$.
- Installation in a dry room in which other technical equipment for operating the swimming pool is installed. The room should be a maximum of 10m from the pool.
- The control unit is designed for wall mounting. It is mounted by means of 4 screws, $\varnothing 4\text{ mm}$ (not included in delivery). It must be fixed in such a way that the cable entries are on the bottom.

Figure 1

Drill hole pattern for BLUE

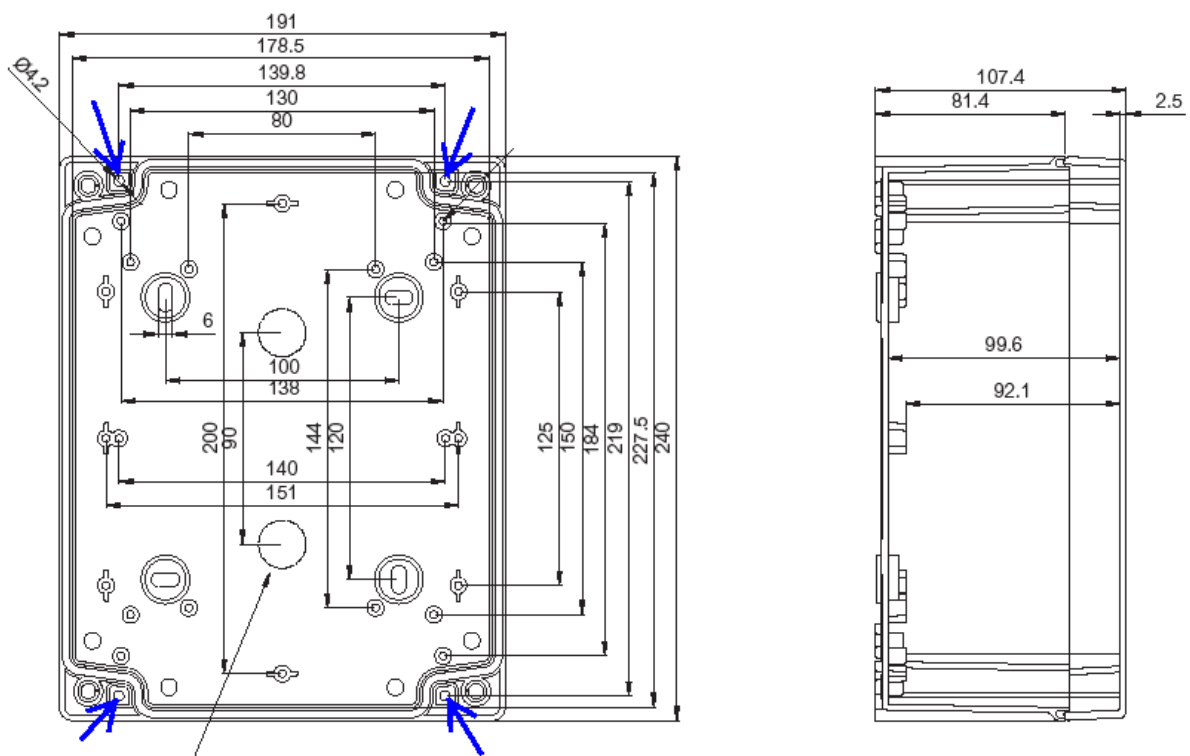

5 Assembly of BLUE

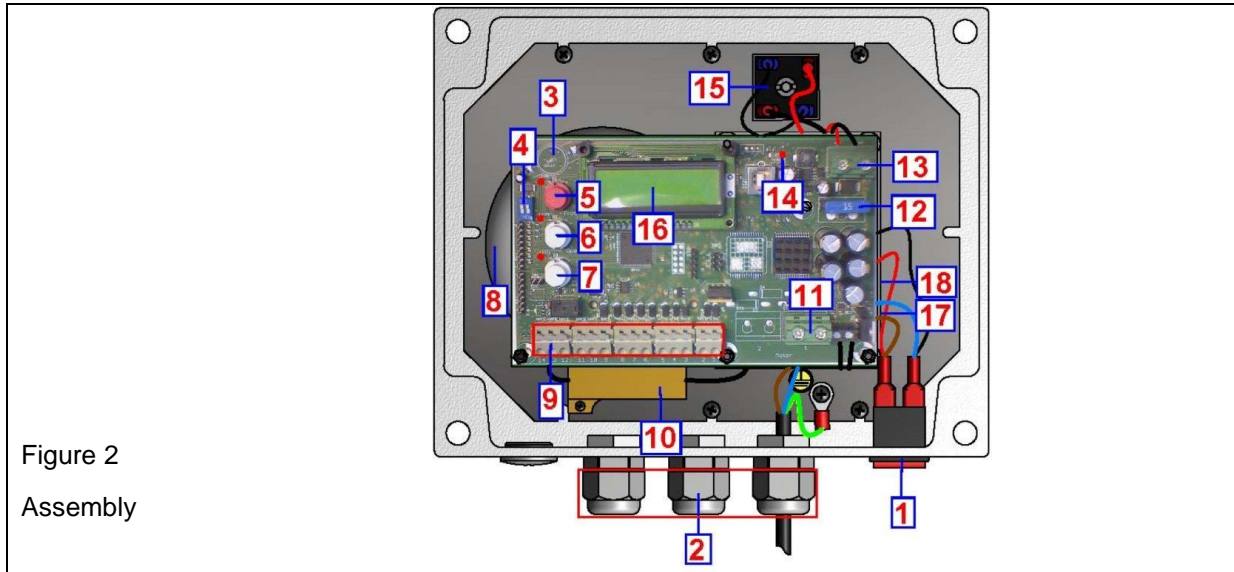

Figure 2
Assembly

1	power switch with control lamp	11	Motor terminal
2	cable inlets M20 x 1.5 Blade fuse ISO 8820-3	12	Motor fuse
3	control panel	13	Terminal 24VDC
4	Dip switch (do not change Off position)	14	LED voltage 24VDC
5	Programming button with LED	15	Rectifier
6	Movement direction open with LED	16	Display
7	Movement direction close with LED hidden under the control panel:		
8	Safety transformer 230/24V	17	Circuit board power connection
9	Terminals labelled 1 - 14	18	Mains fuse 5 x 20 mm, IEC 60127-2
10	Brake resistance		

6 Electrical connection

6.1 Wiring diagram

Figure 3

Wiring diagram (switch is not included in delivery)

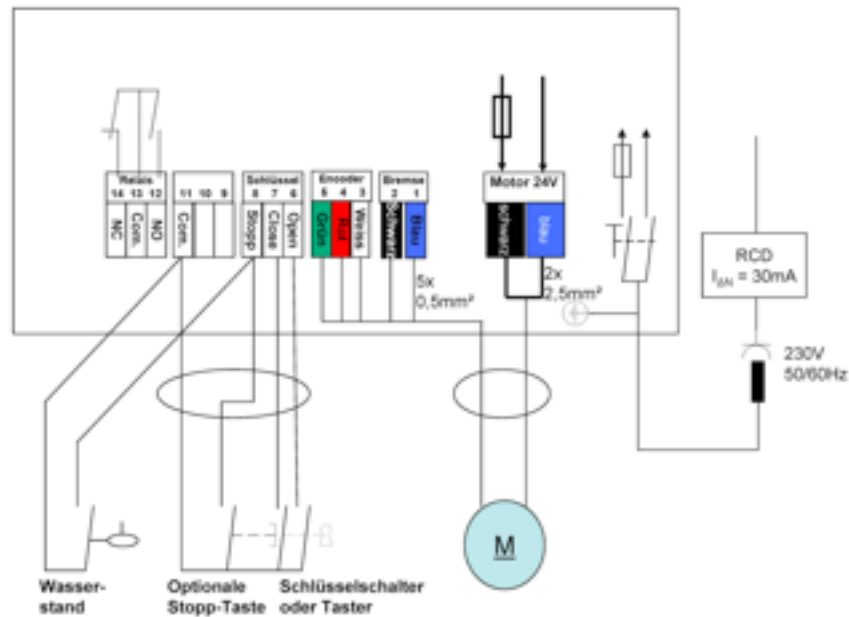

6.2 Cable inlets

All cables must be fed through the plastic cable inlets in the terminal section.

- M25 screw connection for cable diameters from 9mm to 17mm.

) Compliance with IP54 protection class is only assured if

- ... the cables have been properly clamped in the cable inlets.
- ... all cable inlets not in use are sealed with dummy plugs.

6.3 Power connection

The BLUE control unit comes ready for connection with a 1m feed line and shock-proof plug.

6.4 Terminals

- Motor connection (11) screw clamps maximal 4 mm²
 - Screw driver 4 x 0.5, 1.0Nm
- All other spring-loaded clamps for maximum 2.5 mm²

) To release the clamps, press the plastic lever towards the control panel.

} To actuate the lever, use appropriate tools. Levers can break if subjected to too much force. If the terminal or a component on the control panel is damaged, a warranty claim is no longer valid.

6.5 BLUE motor connection



The BLUE motors for pool covers come with an orange connection cable.

)	<ul style="list-style-type: none"> Do not open the motor if the motor feed line requires lengthening! Only use a matching cable for lengthening. The junction boxes must be sealed watertight with a moulding compound. Do not shorten the motor feed line. If shortened, all warranty claim are invalid!
---	---



6.5.1 7-wire connection cable, standard design

The wires are color-coded or labelled with numbers as shown in the table.

- Motor connection **2 x 2,5mm²**

Terminal label (11)	Cable number	Colour	Polarity 24VDC
		Blue 	Changes depending on rotation direction of motor
		Black 	

- Brake coil connection **2 x 0,5mm²**

Terminal number (9)	Cable number	Colour	Polarity 24VDC
1	1	Blue 	Plus +
2	2	Black 	Minus –

- Impulse transmitter connection **3 x 0.5mm²** with mutual shielding (shielding is not connected to the device)



Terminal number (9)	Cable number	Colour	Polarity
3	3	White 	Minus –
4	4	Red 	Plus +
5	5	Green 	Signal

Figure 4



Centre: Motor connection cable 7-wire



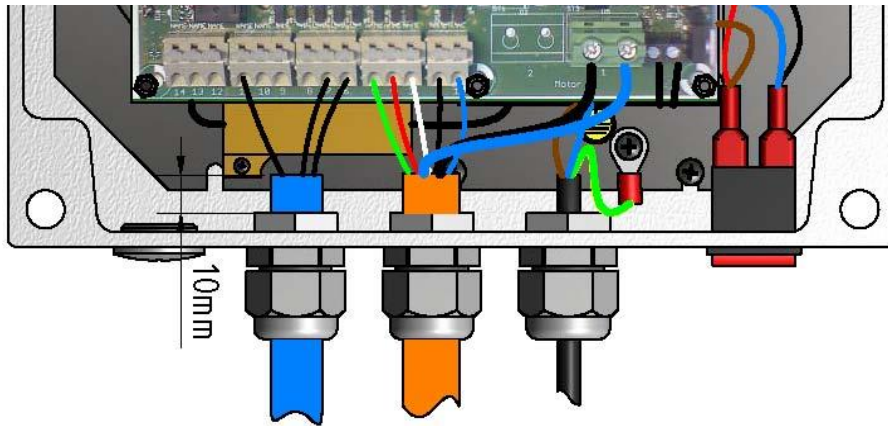

6.5.2 7-wire standard cable, 5-wire motor connecting

Special model or for third party manufacturers. Motor and brake are connected in parallel. No separate brake connection necessary. The wires in BLUE motors are color-coded or labelled with numbers as shown in the following table.

- Motor connection 2 x 2,5mm²

Terminal label (11)	Cable number	Colour	Polarity 24VDC
	without number	Blue 	Changes depending on rotation direction of motor
	without number	Black 	

- Brake connection 2 x 0,5mm² (without pin)

Terminal number (9)	Cable number	Colour	Polarity 24VDC
1 (not occupied) plus +	1 (without pin)	Blue 	Plus +
2 (not occupied) minus -	2 (without pin)	Black 	Minus -

- Impulse transmitter connection 3 x 0.5 mm² with mutual shielding (shielding is not connected to the device)



Terminal number (9)	Cable number	Colour	Polarity
3	3	White 	Minus -
4	4	Red 	Plus +
5	5	Green 	Signal

Figure 5

Centre: Motor connection cable

5-wire

Special model or for third party motors.

6.6 Key switch connection

Terminal number (9)	Function	Colour	
11	Common (0V)	Customer-specified connection	
6	To open		
7	To close		

6.7 Pushbutton connection touch control

Terminal number (9)	Function	Colour	
11	Common (0V)	Customer-specified connection	
6	To open		
7	To close		
8	To stop		

6.8 Water level monitoring connection

The pool cover may only be opened or closed when the water level is sufficient. For switching off if the water level is not sufficient, a potential-free contact for water level monitoring is required. The contact must be closed if the water level is too low. The connection is carried out at terminal 11 and 8 on the strip terminal (9), parallel to the stop button.

7 Start-up

{ DANGER DUE TO ELECTRICAL CURRENT

Before starting the machine up, check the operation of the residual current device (RCD) on the machine side! Check all lines for damage and make sure the electrical connections are secure.

} DANGER

Before switching the machine on, make sure that there are no swimmers in the swimming pool!

7.1 Select language

The language can only be selected during the initial start of operation and will remain until the unit is subjected to a power outage or switched off. If the language is selected after the final positions have been programmed, the selected positions are saved.

- Plug in the shock-proof plug.
- Press and hold the Open button (6) and turn on the power switch (1).
- Hold the Open button (6) down until the "Language" message is shown in the display.
- Release the Open button (6).
- By pressing the close button (7), the desired language (German, English, French, Dutch, Spanish, Italian, or Portuguese) can be selected
- When the desired language is shown in the display, it can be saved by pressing the Open button (5).
- The message "ready" appears on the display in the selected language.

Figure 5:
Select language

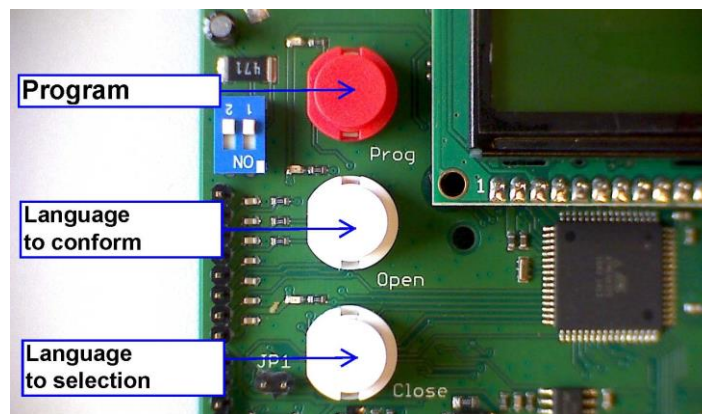

7.2 Programming the final positions

)	<ul style="list-style-type: none"> • When programming the final positions, the operator must have an unobstructed view of the pool. • There is no automatic switch-off. • Movement to the final positions can be actuated by an external switch or with the Open (6) and close (7) button on the control panel, or by using the optional remote control. • We recommend programming with an external switch, and the following is based only on this recommendation.
---	---

7.2.1 Activation

Plug in the shock-proof plug.

- Press the power button (1)
- Control lamp in the power switch is on
 - LED (14) on the control panel is lit
 - LED's for buttons 7, 6 and 5 flash briefly
 - After approximately 5 seconds, the "ready" message appears in the display.
 - The control unit is ready for additional programming

7.2.2 Testing the motor's rotation direction

}	The rotation direction can be tested by the open (6) and close (7) buttons on the control panel. If the pool cover is not within sight, two people are required.
---	--

- Press the open button (6).
- The closed cover must begin opening.
- If the cover moves in the wrong direction, exchange the motor connections at terminal 11.
- The rotation direction should then also be tested with the external switch. If the rotation direction is incorrect when the external switch is activated, correct the connections at terminals 11, 6 and 7.

7.2.3 Programming the OPEN position

The OPEN position indicates that the water surface of the pool is exposed and the cover is completely rolled back.

1. Press and hold the red programming button (5) until "Programming mode" appears on the display. The red LED next to the red button (5) is flashing rapidly.
2. Press the external "open" switch. The red LED next to the OPEN button (6) is lit.
3. When the cover has arrived in the OPEN position, turn off the motor by briefly pressing the switch in the opposite direction. The desired position can be corrected in either direction by means of the pushbuttons. When switching directions, a time delay of 4 seconds must be observed.
4. Turn off the power to the mains switch (1) at the control unit. The final position OPEN is now programmed.

7.2.4 Programming the CLOSED position

The CLOSED position indicates that the water surface of the pool is covered and the cover is extended completely across the water surface.

1. Turn on the power switch (1) The "ready" message is being displayed.
2. Press and hold the red programming button (5) for 3 seconds until "Programming mode" appears on the display.
The red LED next to the red button is flashing rapidly.
3. Press the external "close" switch. The red LED next to the CLOSE button (7) is lit.
4. When the cover has arrived in the CLOSED position, turn off the motor by briefly pressing the switch in the opposite direction. The desired position can be corrected in either direction by means of the pushbuttons. When switching directions, a time delay of 4 seconds must be observed.
5. Press the red program button (5) one time.
 - "Position 1" will appear in the display and the LED next to button (5) is flashing slowly.
6. Press the red program button (5) once again.
 - "Position 2" will appear in the display and the LED next to button (5) is flashing more rapidly.
7. Press the red program button one more time.
 - The desired position is saved.
 - The word "saved" is displayed and the LED next to the red programming button (5) goes off.
 - Both positions are saved and the unit is ready for operation.

7.3 Information shown on display 16

A variety of information is shown on the display, depending on operating mode.

- In standard operating mode, the motor parameters are displayed.

Figure 6
Display information

Figure 7:

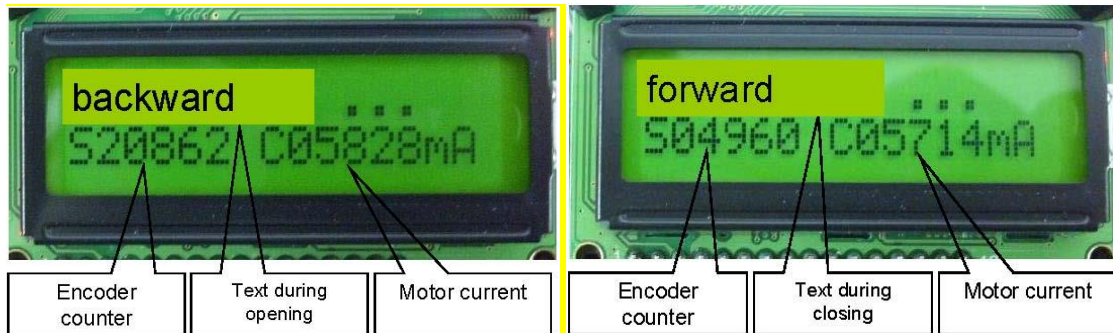

- In programming mode, information pertaining to programming are displayed.
- In the event of malfunction, information regarding the possible cause are displayed. See the section on error messages.

8 Maintenance and upkeep

Only use a damp cloth to clean the control unit. Ensure that the control unit is not covered by objects and is always accessible. The cables must always be fastened in the intended cable inlets. If the housing or cover becomes discoloured, this indicates exposure to excessive temperatures. Pull the shock-proof plug from the mains and contact an expert.

9 Error messages

An error is indicated when the LED's next to the programming buttons 5,6, and 7 flash simultaneously. The display will show an error message in accordance with the following table.

LED error code	Error in display	Possible cause	Remedy
All 3 LED's are flashing	KEY SWITCH BLOCK	Key switch is in the OPEN or CLOSE position	Turn the key switch to the 0 position. The word "ready" appears in the display.
All 3 LED's are flashing	SENSOR ERROR	Decoder not functioning.	Have the unit inspected by a professional technician. The drive runs out of control in this instance.
All 3 LED's are flashing	MAXIMUM CURRENT	Motor is blocked or is rough-running. Items in pool	Remove the items. Have the unit inspected by a professional technician.
none	none	The unit only moves in one direction	Connect the key switch properly. Connect the cable from terminal 6 to terminal 11, or from terminal 7 to terminal 11.
LED for voltage display is not lit	No display	Shock-proof plug has no power. Residual current circuit breaker was activated. Power switch (1) not turned on mains fuse () on the power supply board defective	Check house fuse, have unit inspected by a professional technician. Turn on power switch, check fuse / replace if needed

10 PC connection (USB interface)

)	The operational data of the BLUE can be evaluated and the parameters changed via the USB interface and a Windows PC (Laptop). The required software must be installed on the PC. After changing the parameters, the BLUE must be switched off and back on by the power switch (1).
}	Changing the default values may cause damage or destroy the motor and the control unit. Therefore, changes should only be carried out by persons trained by BLUE!

The following functions of the BLUE can be changed via the USB interface:

- Relays connection stable and drive
- Behaviour of control unit when actuating operating switches, drive mode configuration

10.1 Relays connection functions

10.1.1 "Stable" function, delivery state

The relays switch when the final position has been reached.

- Cover reaches the closed position: Contact 13 – 14 closed, 12 – 13 open
- This switching status remains until the final open position has been reached.
- The cover reaches the open position: Contact 12 – 13 closed, 13 – 14 open
- This switching status remains until the final closed position has been reached.

10.1.2 "Drive" function

The relays switch as soon as the motor begins to turn.

- The control unit switched the motor off: Contact 13 – 14 closed, 13 – 12 open
- The control unit switched the motor on: Contact 12 – 13 closed, 13 – 14 open

10.2 Drive mode configuration

10.2.1 MODE EU 1, Standard configuration

Control unit behaves as described in section 6 "Operation".

10.2.2 MODE EU 2, France

There are special safety regulations which must be observed in France. During the closing process, the button (key switch) must be held in place (dead man switch). The opening process can be started by briefly pressing the corresponding button as with configuration EU 1.

10.2.3 MODE EU 3, Stop operation in both directions

Opening and closing transpire as long as the button or key switch are held in place (hold-down mode).

10.2.4 MODE EU 4, TOUCH CONTROL

Opening and closing are done automatically, after the button or key switch was actuated for at least 1 second.

10.2.5 MODE EU 5, external 1-channel remote control

Is used for buttons with external 1-channel remote control.

- press once = open
- press once = stop
- press once = close
- press once = stop
- press once = open

11 Commissioning certificate

BLUE recommends documenting the start of operation. The following information should be noted:

Date of startup:	
Installer:	
Motor serial number:	
Motor current listed on type plate:	A
Control unit serial number:	
Control unit power listed on type plate:	A
Measurement values	
Motor current before reaching "Closed" position:	A
Motor current before reaching "Open" position:	A
Impulse counter when "closed":	
Impulse counter when "open":	
Travel time from "open" -> "closed":	S
Travel time from "closed" -> "open":	S